

# KAMI INSTALLATION GUIDE

PLEGEL® - PlusPLEGEL® - TerraPLEGEL®

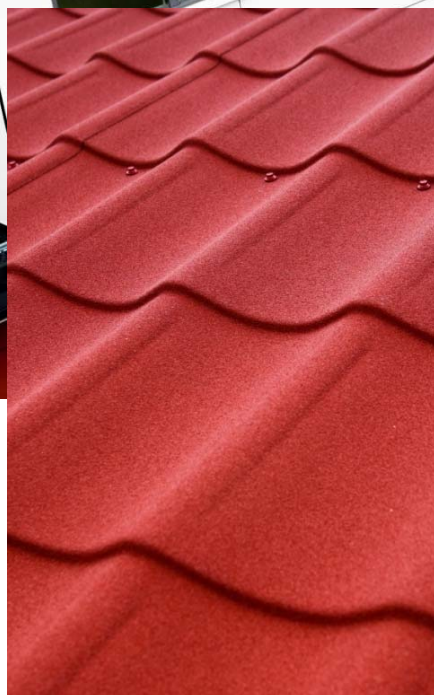

**KAMI**  
*Plegel™ roofing*

**KAMI TERRAPLEGEL, PLUSPLEGEL AND PLEGEL ARE MADE OF 0,5 MM THICK STEEL AND ARE AVILABLE IN BOTH DUTCH AND SCANDINAVIAN PROFILE.**

Dutch profile TerraPLEGEL/PlusPLEGEL/PLEGEL  
Covering width 1010 mm, step length 350 mm

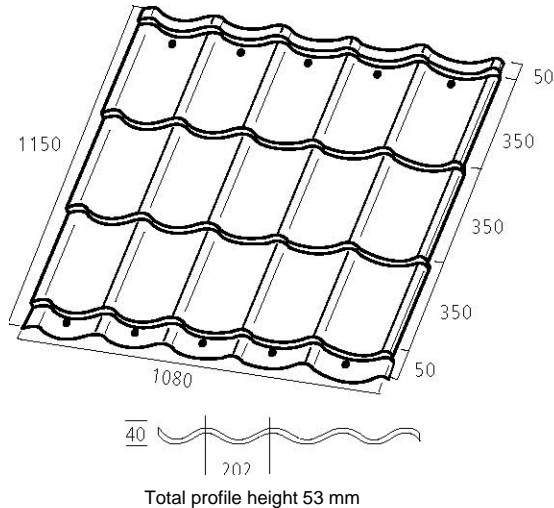

Scandinavian profile TerraPLEGEL/PlusPLEGEL/PLEGEL  
Covering width 1000 mm, step length 350 mm

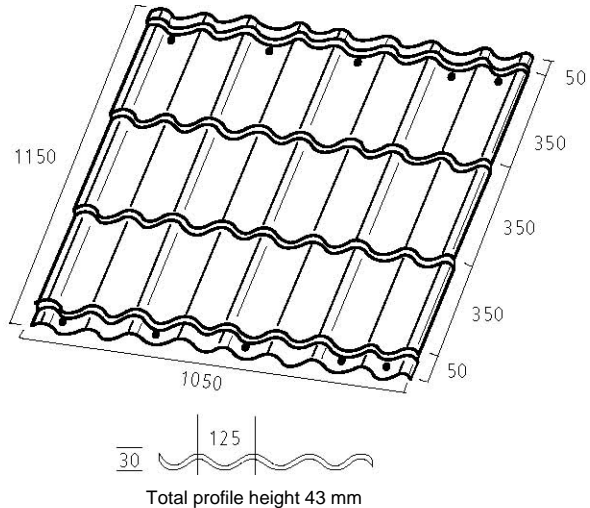

**STEEL ROOF TILES**

TerraPLEGEL, PlusPLEGEL and PLEGEL are made of 0,5 mm thick steel and are available in two profiles, see above pictures. The distance between support battens are C/C 525 mm for full walkability on the whole surface. Self drilling screws are used to fasten the sheets to every second support batten, i.e. C/C 1050 mm, starting from the eave. Please note that exterior forces such as snow loads etc. must be considered and may require that the distance between support battens must be reduced to C/C 350 mm.

**RECOMMENDED MINIMUM ROOF PITCH**

Lowest recommended roof pitch for TerraPLEGEL, PlusPLEGEL and PLEGEL are 14°. Please contact KAMI AB for advice when the roof pitch is lower than 14°.

**HANDLING**

IMPORTANT! The sheets shall in all manual handling be lifted and handled standing on one side. When lifting in the sheet ends the sheets can be deformed which will make them harder to install and fit to each other.

**STORAGE**

If the roof sheets are not installed immediately they shall be stored in a dry place with good ventilation, preferably indoors. Storage during longer periods shall always be done indoors.

Otherwise there is a considerable risk that the sheets are discolored by so called "white rust" that occurs when there is moisture between the stacked sheets. When storing the sheets for a short time outside, please place the pallets slightly leaning in the direction of the steps. This will make it easier for any eventual water to drain from the package.

**PREPARATIONS**

When installing TerraPLEGEL, PlusPLEGEL or PLEGEL on a existing roof material it is important to check the old roof first and repair eventual damages, shift rotten parts and remove any items that may prevent the installation of the new roof. Make sure to plan the installation. If a tin smith shall be hired you need to contact him in good time before the scheduled installation start. If snow stoppers etc. shall be installed it is most convenient to do this when installing the roof. By measuring the roof diagonals you can determine if the roof is perpendicular. If the diagonals are not equal the roof is not perpendicular and it will be especially important to install the sheet in a straight line at the eave. Small angular deviations will be covered by the verge trim.

**TOOLS**

Using a drilling machine with variable rpm and reversible drive will make the installation easier. Normally you also need a hammer, plate shearer or nibbler. When cutting TerraPLEGEL you will need a circular saw or jig saw. Don't use a angle grinder since the hot cut zone and hot residue/spray can damage the coating and thus the protection against corrosion. It is important to remove / sweep away any metal chips etc. from the sheets to avoid damages and discoloration of the surface coating.

**MAINTENANCE**

If open cut edges and damages in the surface coating occurs during installation it is important that these are sealed with touch up paint to increase the roof lifetime. No roofing material is totally free from maintenance and we recommend that you inspect and repair any damages regularly. It is especially important that cutting edges at over lapping sheets and sheet ends are controlled and painted. Always order touch up paint together with your sheet delivery. Read more in "Kami recommendations for inspection and maintenance".

## INSTALLATION

It is very important to start correctly. TerraPLEGEL, PlusPLEGEL and PLEGEL are installed in rows from eave to ridge starting from the bottom right side of the roof. Make sure that the eave plate is installed in a straight line and perpendicular to the roof slope.

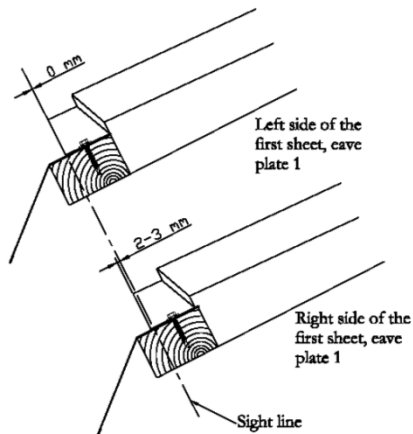
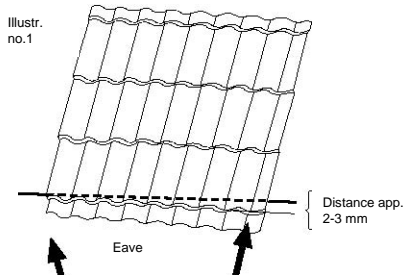

The first sheet should be installed with a small angle to the roof slope. This means that the first step should connect to the vertical edge of eave plate 3 on the left side and have a distance of about 2-3 mm to the vertical edge of eave plate 3 on the right side, see illustration no.1. On the following sheets the first step to the left shall connect continuously to the vertical edge of eave plate 3. On the right side where the side overlap is the first step shall connect to the first step of the previous sheet. If you use eave plate 1 we recommend that you mark a straight line along the eave or use a guide line and follow this during installation. The same adaption with the 2-3 mm on the first sheet shall be done.

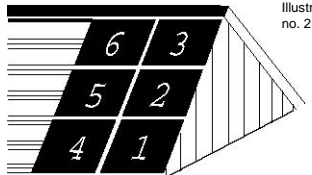

Recommendation: Fasten the first 3-5 pcs of sheets with only a few screws until you know that you have started correctly. Then fasten the remaining screws, see illustration no. 2. When you have a horizontal joint on the roof you should always start with a sheet with no. of plegel, (steps), evenly divided by three. In this way the horizontal joint will be on a batten when using batten distance C/C 525 mm. This is also valid for the second sheet from the eave if you have more than one horizontal joint. The last sheet, see sheet no. 3 and 6 in illustration 2 above, can have a special length. To avoid leakage in the side overlaps the sheets shall be thoroughly pressed together when installed. Since TerraPLEGEL, PlusPLEGEL and PLEGEL are profiled in both x- and y axis it is important to follow above recommendations to compensate for the thickness and tolerances of the sheets.

## OPTION FOR EAVE

In some areas/countries it is custom to install the sheets a little further down on the eave plate or even let the sheets point out a little over the eave plate. You will then have to compensate for this on the C/C distance between the first and the second support batten. If you let the sheet go down 20 mm on the eave plate you have to reduce the first batten distance with 20 mm.

## Fastening

TerraPLEGEL, PlusPLEGEL and PLEGEL are normally fastened directly to the support batten with self drilling screws, see illustration no. 3 below. The screw is equipped with sealing washer and has the dimension of 4,8 x 35 mm.

Illustr. no. 3 – Normal installation



If you use KAMI support battens made of steel, KBL, you can use self drilling screws with dimension 4,8 x 20 mm, equipped with sealing washer. To make the installation easier you can use our specially adapted hollow screw key which can be supplied upon request. We recommend to use six to seven screws / m<sup>2</sup>, see illustrations on page no. 2, and that you use more screws in critical areas such as eave, ridge, verge, etc

## CUTTING

Lay the sheet on a rigid underlay and fix it with for example a clamp. Then mark the imagined cutting line and cut it with for example a nibbler. For smaller holes and cuts it is usually enough with a plate shearer or jig saw. TerraPLEGEL is cut with a circular saw equipped with our special saw disc. It is available in two dimensions, Ø180 mm – recommended no. of revolutions about 2 600 rpm and Ø200 mm – recommended no. of revolutions about 2 400 rpm. Remember to seal of all open cut edges with touch up paint after cutting.

## SIDE OVERLAP (see illustr. no. 4)

The side overlap is normally one corrugation and the fit can be approved with side overlap screws, pop rivets, seal strips etc. By moving and angle the fastening screws a little to the side you will force the sheets in the direction of the arrows and thereby get a tighter overlap.

Illustr. no.4 – Fastening in side overlap

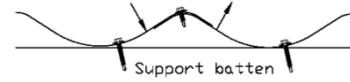

## END OVERLAP

The shape of TerraPLEGEL, PlusPLEGEL and PLEGEL will fix the end overlap which normally is 100 mm. Always screw through both sheets in every profile valley in the end overlap.

## Plastic film / breather membrane directly on roof trusses

The underlay, (plastic film, board etc.), approved by regulating authority, is fastened on the roof trusses. The support battens are then installed on the roof trusses.

All battens and fastenings must be correctly dimensioned corresponding to the applicable loads.  
NOTE! Never use battens made of impregnated wood.

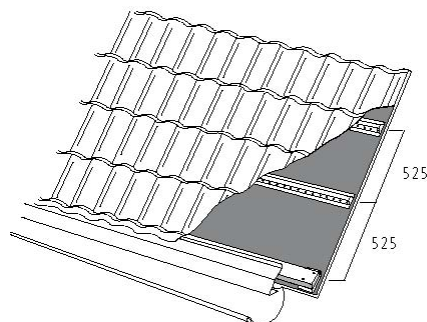

## Installation on battens and counter battens

Existing felt laid over full boarded roof

The approved underlay is installed according to the manufacturers instructions. Install counter battens and support battens. If during renovating any board is found to be affected by rot or the under roof is damaged in any other way it has to be replaced / repaired. Any other unevenness or flaws should also be corrected when installing the battens.

Counter battens: C/C distance 300 mm at the eave under the first three support battens and maximum C/C distance 600 mm on the rest of the roof. All battens and fastenings must be correctly dimensioned corresponding to the applicable loads.

NOTE! Never use battens made of impregnated wood.

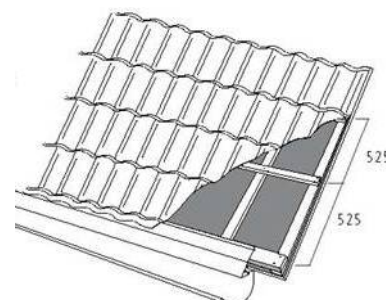

## Existing roof of corrugated fiber cement

The method means that Kami counter batten, KSL, is installed in the valleys of the corrugated fiber cement elements with C/C distance according to table no.1. The counter batten is screwed with self drilling screw KES 4,8x60mm to each existing support batten. Note that our 15x3 mm seal band shall be attached to the counter batten before installation to minimize the dust from the fiber cement from being emitted to the air when screwing. Screw through the seal band. Kami support batten KBL is then screwed to the counter batten KSL with two self drilling screws, dim. 4,8x20 mm, in each intersection, diagonally in the upper- and lower flange of the support batten.

The support batten is installed with 100-200 mm over lap and a C/C distance according to table no. 2. The sheets are screwed to the support battens with self drilling screws, dim. 4,8x20 mm, equipped with sealing washers. Further information is available from Kami upon request.

Table no. 1

Type of fibre cement	Snow zone	Counter batten dist. C/C mm
P6	1, 1.5, 2	1239
P6	2.5, 3	1062
P6	3.5, 5	885
P8	1, 1.5, 2	1170
P8	2.5, 3	1040
P8	3.5, 4	910

Table no. 2

TerraPLEGEL/PlusPLEGEL/PLEGEL	Batten distance, C/C mm
	1, 1.5, 2, 2.5, 3
	525
	3.5, 4
	350

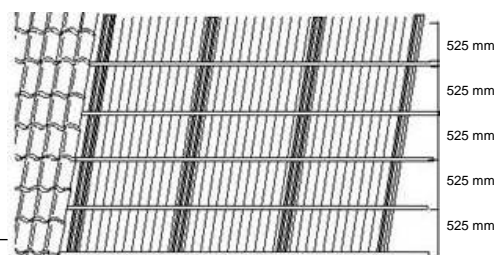

### Note!

Fiber cement roofing material may contain asbestos and you must always make sure to conform with the local regulation when handling this material.

# Details and accessories

## Valley gutter

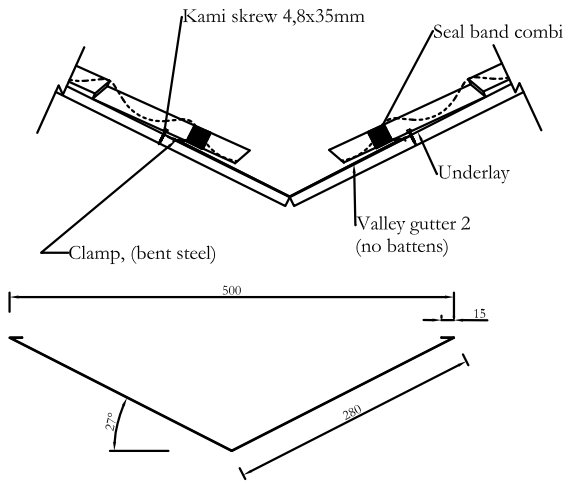

## Kami screw 4,8x35mm

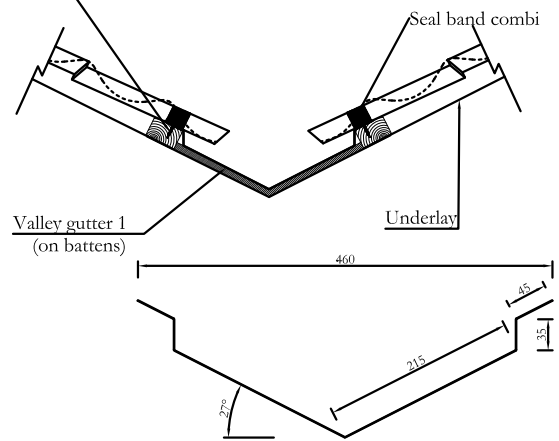

The distance from the middle of the valley gutter to the sheet edge should be at least 120 mm to make it easy to clean. The roof sheet should overlap the edge of the valley gutter with at least 150 mm. Valley gutters shall be installed with a minimum overlap of 300 mm.

## Roof outlet with junction sheet

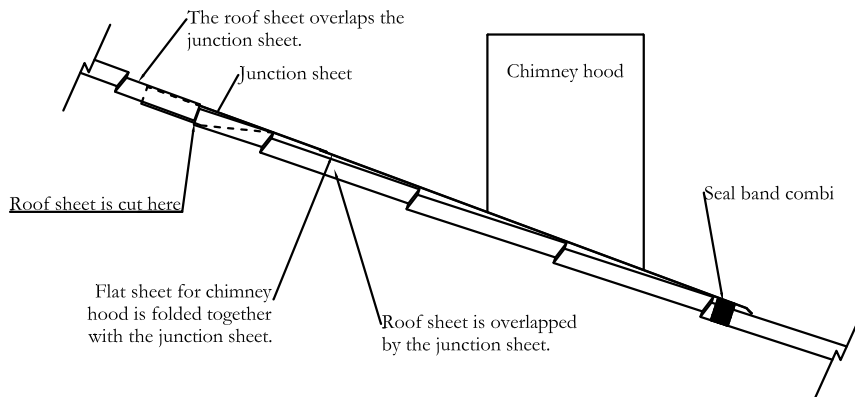

## Ridge tile

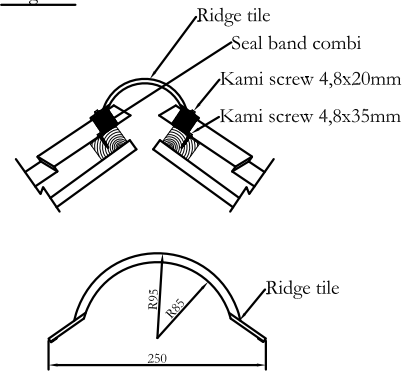

## Mansard roof

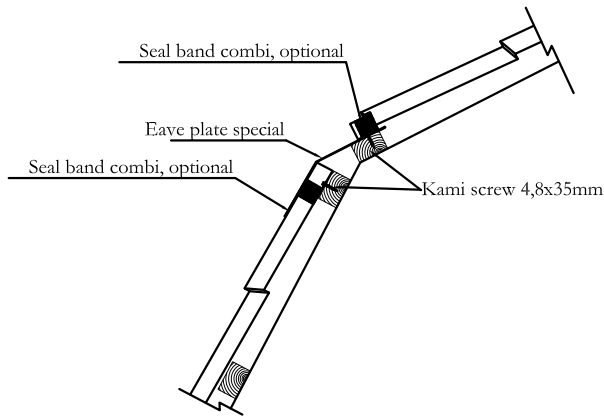

## Verge trim

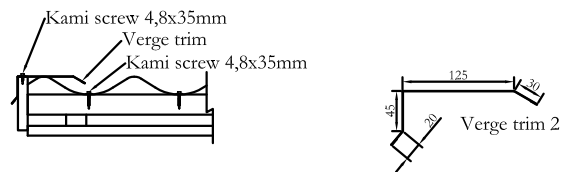

## Eave plate

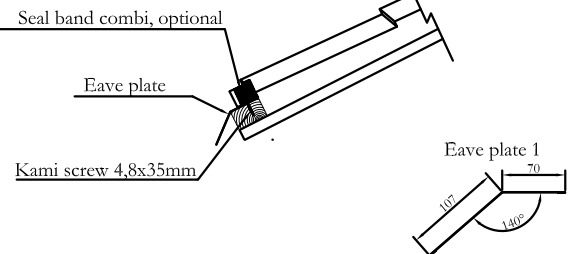

## Connection to facade

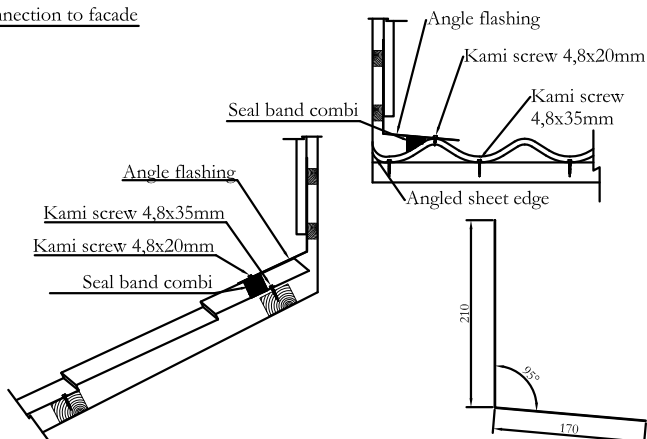

## Rubber pipe flashing

Adapt the hole of the rubber pipe flashing to the diameter of the pipe. Make the hole diameter about 10mm smaller than the pipe diameter. Apply silicone under the rubber sealing, form the metal ring against the sheet and screw it to the sheet with self drilling screws, dim. 4,8x20mm, equipped with sealing washer.

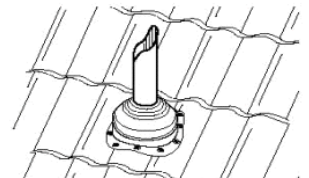

Note! When the roof slope is perpendicular to the seal bands it is possible to use a profiled non ventilating seal band.

## ...more accessories

Junction sheet, Dutch profile



Hollow screw key



Junction sheet, Scandinavian profile



Counter kit, KSB

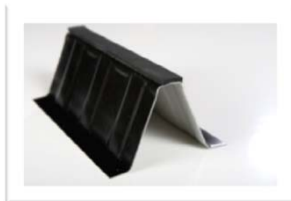

Counter batten, KSL



Fastening plate, KIPR



Support batten, KBL



Profiled seal band, Dutch profile



Profiled seal band, Scandinavian profile



Seal band combi, ventilated



End cap



Quartz sand



Rubber pipe flashing



Touch up paint



Saw blade for circular saw



Overlap screw, KTS 4,8x20mm



Screw, KTS 4,8x35mm



Screw, KES 4,8x60mm

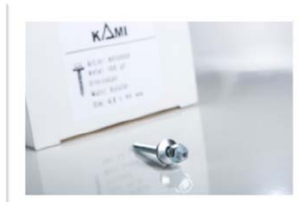

Seal band 15x3 mm



## Specify your type of roof

To be able to help you specify your needs and give you a correct quotation we kindly ask you to fill in below formular and bring this with you to you meeting with us or our retailers.

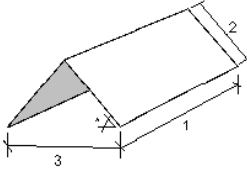
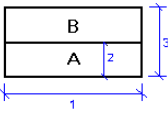
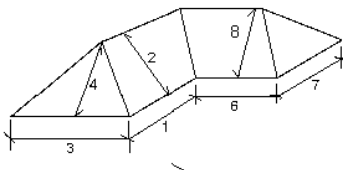
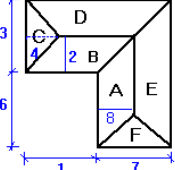
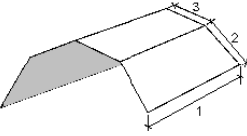
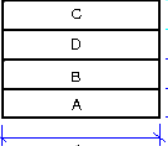
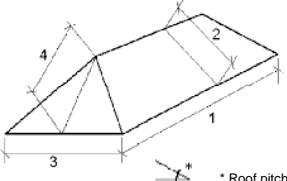
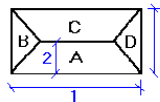
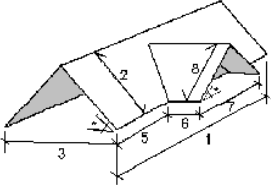
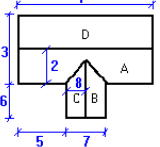
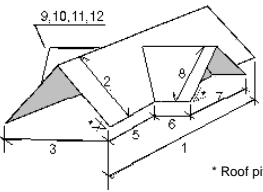
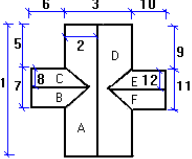
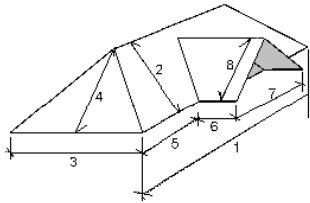
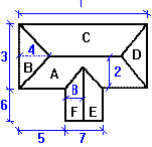
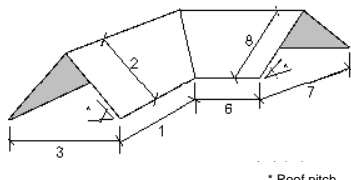
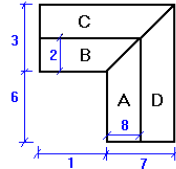
 <p>* Roof pitch</p>  <p>My roof</p>	 <p>* Roof pitch</p>  <p>My roof</p>
 <p>* Roof pitch</p>  <p>My roof</p>	 <p>* Roof pitch</p>  <p>My roof</p>
 <p>* Roof pitch</p>  <p>My roof</p>	 <p>* Roof pitch</p>  <p>My roof</p>
 <p>* Roof pitch</p>  <p>My roof</p>	 <p>* Roof pitch</p>  <p>My roof</p>

## Dimensions:

Determine your roof type above and fill in the relevant dimensions below

1 = \_\_\_\_\_ mm

5 = \_\_\_\_\_ mm

9 = \_\_\_\_\_ mm

2 = \_\_\_\_\_ mm

6 = \_\_\_\_\_ mm

10 = \_\_\_\_\_ mm

3 = \_\_\_\_\_ mm

7 = \_\_\_\_\_ mm

11 = \_\_\_\_\_ mm

4 = \_\_\_\_\_ mm

8 = \_\_\_\_\_ mm

12 = \_\_\_\_\_ mm



Should you have any questions or require further information, please contact us on below address / phone no.

Phone no. connection board:	+46 923 12120
Phone no. customer service:	+46 923 79850
Fax:	+46 923 10488
E-mail:	<a href="mailto:info@kami.se">info@kami.se</a>
Web:	<a href="http://www.kami.se">www.kami.se</a>

Visiting address:	Vintervägen 16 S-952 61 Kalix Sweden
-------------------	--

Postal address:	Box 10130 S-952 27 Kalix Sweden
-----------------	---------------------------------------